



**KAYA
ROPES**

**FISH
FARMING
ROPES**

2022 | ENG

Upgrade Your Lines





KAYA COMPANIES

www.kayacompanies.com

Kaya Companies;

A leader in its field today, Kaya Group began business in the 1980's as Kaya Construction. Kaya Group is now preparing to celebrate its 40th year of operation. Kaya Group concentrates its knowledge and experience in four main areas of activity; the production of technical ropes, industrial work safety and work at height, health and safety at work training and consulting services. Since being fully aware of the dimension of social responsibility attached to the sector, the company obtains national and international certificates for all products that are developed and manufactured.

By providing education and consultation services concerning the correct use of its products, the Kaya Group has gained the knowledge, experience and level of competence that have given the company the confidence and resources to be able to make new advances from a sound base. With its 40- year experience, the Kaya Group is the largest organization in the sector. In 2010, with new products, services and investments, the company is firmly on the path towards becoming an important brand in the international market.

Our Vision;

To make Kaya the undisputed world's strongest, most prestigious and trusted brand in its sector.

Mission Statement;

Our mission is to conduct research and development based on accurate analysis of needs in the sector and thereby develop new products; to employ modern machinery and a competent workforce in the manufacture of world-class, high quality goods; to provide training and consulting services to create knowledgeable workers and managers and help establish a culture of work safety in Turkey; and to provide complete solutions Via our integrated services.

Company Philosophy;

Based on the value we place on human life, our goal is to design products that will safeguard human life on the job, to manufacture such products and to raise awareness about work safety by training workers and managers and providing consultation services in this regard.

KAYA ROPES

KAYA TRAINING

KAYA SAFETY

KAYA CONSTRUCTION

KAYA LIFTING

KAYA DEFENCE

KAYA ADVENTURE

KAYA SPORT

KAYA CONSULTING

KAYA RESCUE

KAYA ARCHITECTURE

KAYA NATURAL



DYNE K®

APPLICATIONS

- General Working Line
- Wire Rope Replacement
- Purse Seine Line
- Trawl/Bridle Line
- Lifting Sling (Static)
- Bridle Line (Fish Farming)
- Other Fishing Line

BENEFITS / FEATURES

- Superior Abrasion Resistance
- Excellent Breaking Load (SK99)
- Buoyant
- Durable
- Very Low Stretch
- Lightweight
- Easy to Splice
- Does not Kink

SPECIFICATIONS

Material	: Coated Dyneema® SK 78/99
Specific Gravity	: 0,97 kg/dm ³
Construction	: 12 Strand Braided
UV Resistance	: Excellent
Chemical Resistance	: Excellent
Melting Point	: 147°C
Critical Temperature	: 65°C
Working Stretch	: <1%
Fiber Water Absorption	: None
Wet Abrasion	: Excellent
Dry Abrasion	: Excellent
Standard	: ISO 10325
Length	: 100-200 m Plastic/Wooden Spool or Coil

Other Colours & Larger Diameters Upon Request

DIA (mm)	Weight (kg/100m)	B.Load (kgf) SK78	B.Load (kgf) SK99	DIA (inch)	Weight (lbs/100ft)	B.Load (lbs) SK78	B.Load (lbs) SK99
2	0,25	425	502	5/64"	0,17	935	1.104
3	0,50	950	1.121	1/8"	0,34	2.090	2.466
4	0,95	1.650	1.947	5/32"	0,64	3.630	4.283
5	1,50	2.600	3.068	3/16"	1,01	5.720	6.750
6	2,30	3.750	4.425	1/4"	1,55	8.250	9.735
8	4,00	6.600	7.788	5/16"	2,69	14.520	17.134
10	6,10	10.400	12.272	3/8"	4,10	22.880	26.998
12	8,70	15.000	17.700	1/2"	5,85	33.000	38.940
14	11,70	20.400	24.072	9/16"	7,86	44.880	52.958
16	15,10	26.520	31.294	5/8"	10,15	58.344	68.847
18	19,00	31.620	37.312	3/4"	12,77	69.564	82.086
20	23,20	38.760	45.737	13/16"	15,59	85.272	100.621
22	28,10	45.900	54.162	7/8"	18,88	100.980	119.156
24	33,10	53.000	62.540	1"	22,24	116.600	137.588
26	38,40	61.200	72.200	1-1/16"	25,80	134.640	158.840
28	44,50	69.360	81.800	1-1/8"	29,90	152.592	179.960
30	50,60	78.540	92.600	1-1/4"	34,00	172.788	203.720
32	57,50	88.740	104.700	1-5/16"	38,64	195.228	230.340
34	64,80	97.920	115.500	1 3/8"	43,55	215.424	254.100
36	72,00	106.080	125.150	1-1/2"	48,38	233.376	275.330
38	79,80	118.320	139.600	1 9/16"	53,63	260.304	307.120
40	88,10	128.520	151.650	1-5/8"	59,20	282.744	333.630

*Unspliced Break Load (All Tests are in Accordance with ISO 2307)

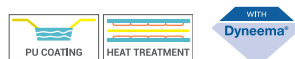

APPLICATIONS

General Working Line
 Wire Rope Replacement
 Purse Seine Line
 Trawl/Bridle Line
 Lifting Sling (Static)
 Bridle Line (Fish Farming)
 Other Fishing Line

BENEFITS / FEATURES

Superior Abrasion Resistance
 Excellent Breaking Load
 Buoyant
 Durable
 Very Low Stretch
 Lightweight
 Easy to Splice
 Does not Kink

SPECIFICATIONS

Material	: Coated UHMWPE Fiber
Specific Gravity	: 0,97 kg/dm ³
Construction	: 12 Strand Braided
UV Resistance	: Excellent
Chemical Resistance	: Excellent
Melting Point	: 147°C
Critical Temperature	: 65°C
Working Stretch	: <1,5%
Fiber Water Absorption	: None
Wet Abrasion	: Excellent
Dry Abrasion	: Excellent
Standard	: -
Length	: 100-200 m Plastic/Wooden Spool or Coil

Other Colours & Larger Diameters Upon Request

DIA (mm)	Weight (kg/100m)	Min. B.Load (kgf) Unspliced	Min. B.Load (kgf) Spliced	DIA (inch)	Weight (lbs/100ft)	Min. B.Load (lbs) Unspliced	Min. B.Load (lbs) Spliced
2	0,25	404	364	5/64"	0,17	888	800
3	0,50	903	813	1/8"	0,34	1.986	1.789
4	0,95	1.568	1.412	5/32"	0,64	3.449	3.107
5	1,50	2.470	2.225	3/16"	1,01	5.434	4.895
6	2,30	3.563	3.192	1/4"	1,55	7.838	7.022
8	4,00	6.270	5.681	5/16"	2,69	13.794	12.498
10	6,10	9.880	8.911	3/8"	4,10	21.736	19.604
12	8,70	14.250	12.787	1/2"	5,85	31.350	28.131
14	11,70	19.380	17.442	9/16"	7,86	42.636	38.372
16	15,10	25.194	22.515	5/8"	10,15	55.427	49.533
18	19,00	30.039	27.075	3/4"	12,77	66.086	59.565
20	23,20	36.822	32.300	13/16"	15,59	81.008	71.060
22	28,10	43.605	38.760	7/8"	18,88	95.931	85.272
24	33,10	50.350	45.543	1"	22,24	110.770	100.195
26	38,40	58.140	52.326	1-1/16"	25,80	127.908	115.117
28	44,50	65.892	59.109	1-1/8"	29,90	144.962	130.040
30	50,60	74.613	66.861	1-1/4"	34,00	164.149	147.094
32	57,50	84.303	75.582	1-5/16"	38,64	185.467	166.280
34	64,80	93.024	83.334	1 3/8"	43,55	204.653	183.335
36	72,00	100.776	91.086	1-1/2"	48,38	221.707	200.389
38	79,80	112.404	100.776	1 9/16"	53,63	247.289	221.707
40	88,10	122.094	109.497	1-5/8"	59,20	268.607	240.893

*Unspliced Break Load (All Tests are in Accordance with ISO 2307)



FORCE K[®] ▲ FISH FARMING ROPES



LUPP® SQUARE FILM

APPLICATIONS

General Working Line
 Purse Seine Line
 Trawl/Bridle Line
 Bridle Line (Fish Farming)
 Other Fishing Line

BENEFITS / FEATURES

Excellent Grip
 Moderate Elongation
 Buoyant
 Economically Priced
 Does not Kink
 Easy to Splice
 %25-30 More Strength than Normal
 PP Ropes



SPECIFICATIONS

Material	:	100% HT Polyolefin Film Fiber
Type	:	L
Specific Gravity	:	0,94 kg/dm ³
Construction	:	8 Strand Plaited (4x2)
UV Resistance	:	Sufficient
Chemical Resistance	:	Very Good
Melting Point	:	165°C
Critical Temperature	:	80°C
Elongation At Break	:	Approx.23%
Fiber Water Absorption	:	None
Wet Abrasion	:	Sufficient
Dry Abrasion	:	Sufficient
Standard	:	ISO 10572
Length	:	200-220 m Coil

Other Colours on Request

DIA (mm)	Weight (kg/220m)	Min. B.load (Kgf) Unspliced	DIA (inch)	Weight (lbs/220ft)	Min. B.Load (lbs) Unspliced
40	158,00	26.300	1-5/8"	106,18	57.860
48	229,00	37.500	2"	153,89	82.500
56	312,00	53.100	2-1/4"	209,66	116.820
64	407,00	68.700	2-5/8"	273,50	151.140
72	515,00	86.000	3"	346,08	189.200
80	638,00	105.800	3-1/4"	428,73	232.760
88	772,00	125.000	3-5/8"	518,78	275.000
96	917,00	150.200	4"	616,22	330.440

*Unspliced Break Load (All tests are in Accordance with ISO 2307)



LUPP® TWIST FILM

APPLICATIONS

General Working Line
 Purse Seine Line
 Crab Rope
 Longline
 Buoy Line (Fish Farming)
 Other Fishing Line

BENEFITS / FEATURES

Does not Harden
 Soft Hand
 Economically Priced
 Buoyant
 Easy to Splice



SPECIFICATIONS

Material	: 100% HT Polypropylene Film Fiber
Type	: A
Specific Gravity	: 0,91 kg/dm ³
Construction	: 3 Strand Plaited
UV Resistance	: Sufficient
Chemical Resistance	: Very Good
Melting Point	: 165°C
Critical Temperature	: 80°C
Elongation At Break	: Approx. %23
Fiber Water Absorption	: None
Wet Abrasion	: Sufficient
Dry Abrasion	: Sufficient
Standard	: EN ISO 1346
Length	: 200-220 m Coil

Other Colours on Request

DIA (mm)	Weight (kg/100m)	Min. B. Load (kgf)	DIA (inch)	Weight (lbs/100ft)	Min. B. Load (lbs)
8	2,89	1.040	5/16"	1,94	2.288
10	4,52	1.530	3/8"	3,04	3.366
12	6,51	2.170	1/2"	4,37	4.774
14	8,86	2.490	9/16"	5,95	5.478
16	11,60	3.700	5/8"	7,80	8.140
18	14,60	4.720	3/4"	9,81	10.384
20	18,10	5.690	13/16"	12,16	12.518
24	26,00	7.920	1"	17,47	17.424
28	35,40	10.500	1-1/8"	23,79	23.100
32	46,30	13.200	1-5/16"	31,11	29.040
36	58,60	16.600	1-1/2"	39,38	36.520

*Unspliced Break Load (All tests are in Accordance with ISO 2307)



LUPP® TWIST FILM ▲ FISH FARMING ROPES



LUPA® SQUARE

APPLICATIONS

General Working Line
 Purse Seine Line
 Trawl/Bridle Line
 Anchor Line (Fish Farming)
 Grid Line (Fish Farming)
 Other Fishing Line

BENEFITS / FEATURES

Does not Harden
 Does not Kink
 Soft Hand
 Durable
 High Breaking Load
 Excellent Shock Absorption
 Easy to Splice



SPECIFICATIONS

Material	:	100% HT Polyamide Fiber
Type	:	L
Specific Gravity	:	1,14 kg/dm ³
Construction	:	8 Strand Plaited (4x2)
UV Resistance	:	Very Good
Chemical Resistance	:	Good
Melting Point	:	218°C
Critical Temperature	:	130°C
Elongation At Break	:	Approx. %30-35
Fiber Water Absorption	:	Approx. %3-4
Wet Abrasion	:	Sufficient
Dry Abrasion	:	Good
Standard	:	EN ISO 1140
Length	:	100-200 m Plastic/Wooden Spool or Coil

Other Colours on Request

DIA (mm)	Weight (kg/100m)	Min. B.Load (kgf)	DIA (inch)	Weight (lbs/100ft)	Min. B.Load (lbs)
12	9,00	3.060	1/2"	6,05	6.732
14	12,30	4.250	9/16"	8,27	9.350
16	16,00	5.400	5/8"	10,75	11.880
18	20,50	6.875	3/4"	13,78	15.125
20	25,00	8.500	13/16"	16,80	18.700
22	30,50	10.250	7/8"	20,50	22.550
24	36,00	12.000	1"	24,19	26.400
26	42,50	14.500	1-1/16"	28,56	31.900
28	49,00	17.000	1-1/8"	32,93	37.400
30	56,00	19.000	1-1/4"	37,63	41.800
32	64,00	21.125	1-5/16"	43,01	46.475
34	72,50	24.310	1-3/8"	48,72	53.482
36	81,00	27.500	1-1/2"	54,43	60.500
38	90,50	30.750	1-9/16"	60,82	67.650
40	100,00	34.000	1-5/8"	67,20	74.800

*Unspliced Break Load (All tests are in Accordance with ISO 2307)



LUPA® ROUND

APPLICATIONS

General Working Line
 Purse Seine Line
 Trawl/Bridle Line
 Anchor Line (Fish Farming)
 Grid Line (Fish Farming)
 Other Fishing Line

BENEFITS / FEATURES

Does not Harden
 Does not Kink
 Soft Hand
 Durable
 High Breaking Load
 Excellent Shock Absorption
 Easy to Splice

SPECIFICATIONS

Material : 100% HT Polyamide Fiber
 Type : T
 Specific Gravity : 1,14 kg/dm³
 Construction : 12 Strand Plaited
 UV Resistance : Very Good
 Chemical Resistance : Good
 Melting Point : 218°C
 Critical Temperature : 130°C
 Elongation At Break : Approx.%30-35
 Fiber Water Absorption : Approx. %3-4
 Wet Abrasion : Sufficient
 Dry Abrasion : Good
 Standard : EN ISO 1140
 Length : 100-200 m Wooden Spool or Coil

Other Colours on Request

DIA (mm)	Weight (kg/100m)	Min. B.Load (kgf)	DIA (inch)	Weight (lbs/100ft)	Min. B.Load (lbs)
18	23,00	8.000	3/4"	15,46	17.600
20	25,00	8.670	13/16"	16,80	19.074
22	30,50	10.300	7/8"	20,50	22.660
24	36,00	12.030	1"	24,19	26.466
26	42,50	14.500	1-1/16"	28,56	31.900
28	49,00	17.000	1-1/8"	32,93	37.400
30	56,00	19.000	1-1/4"	37,63	41.800
32	64,00	21.125	1-5/16"	43,01	46.475
34	72,50	24.310	1 3/8"	48,72	53.482
36	81,00	27.500	1-1/2"	54,43	60.500
38	90,50	30.750	1-9/16"	60,82	67.650
40	100,00	34.000	1-5/8"	67,20	74.800
42	110,50	37.500	1-11/16"	74,26	82.500
44	121,00	41.000	1-3/4"	81,31	90.200
46	132,50	44.500	1-13/16"	89,04	97.900
48	144,20	48.000	2"	96,90	105.600
52	170,00	58.000	2-1/8"	114,24	127.600
56	197,00	68.000	2-1/4"	132,38	149.600
60	226,00	76.250	2-1/2"	151,87	167.750
64	257,00	84.500	2-5/8"	172,70	185.900
72	325,00	110.000	3"	218,40	242.000
80	401,00	129.000	3-1/4"	269,47	283.800
88	486,00	152.000	3-5/8"	326,59	334.400
96	578,00	183.000	4"	388,41	402.600

*Unspliced Break Load (All tests are in Accordance with ISO 2307)



LUPA® ROUND ▲ FISH FARMING ROPES



LUPA® TWIST

APPLICATIONS

General Working Line
 Trawl/Bridle Line
 Longline
 Anchor Line (Fish Farming)
 Grid Line (Fish Farming)
 Other Fishing Line

BENEFITS / FEATURES

Does not Harden
 Soft Hand
 Durable
 High Breaking Load
 Excellent Shock Absorption
 Easy to Splice

SPECIFICATIONS

Material : 100% HT Polyamide Fiber
 Type : A
 Specific Gravity : 1,14 kg/dm³
 Construction : 3 Strand Plaited
 UV Resistance : Very Good
 Chemical Resistance : Good
 Melting Point : 218°C
 Critical Temperature : 130°C
 Elongation At Break : Approx. %30-35
 Fiber Water Absorption : Approx. %3-4
 Wet Abrasion : Sufficient
 Dry Abrasion : Good
 Standard : EN ISO 1140
 Length : 200 m Plastic/Wooden Spool or Coil

Other Colours on Request

DIA (mm)	Weight (kg/100m)	Min. B.Load (kgf)	DIA (inch)	Weight (lbs/100ft)	Min. B.Load (lbs)
4	0,98	380	5/32"	0,66	836
5	1,54	570	3/16"	1,03	1.254
6	2,22	810	1/4"	1,49	1.782
8	3,95	1.420	5/16"	2,65	3.124
10	6,17	2.160	3/8"	4,15	4.752
12	8,88	3.060	1/2"	5,97	6.732
14	12,10	4.250	9/16"	8,13	9.350
16	15,80	5.280	5/8"	10,62	11.616
18	20,00	6.875	3/4"	13,44	15.125
20	24,70	8.500	13/16"	16,60	18.700
22	29,90	10.250	7/8"	20,09	22.550
24	35,50	12.000	1"	23,86	26.400
26	41,70	14.500	1-1/16"	28,02	31.900
28	48,40	17.000	1-1/8"	32,52	37.400
30	55,50	19.000	1-1/4"	37,30	41.800
32	63,20	21.125	1-5/16"	42,47	46.475
36	80,00	27.500	1-1/2"	53,76	60.500
40	98,70	34.000	1-5/8"	66,33	74.800
48	142,00	48.000	2"	95,42	105.600
56	193,00	68.000	2-1/4"	129,70	149.600
64	253,00	84.500	2-5/8"	170,02	185.900

*Unspliced Break Load (All tests are in Accordance with ISO 2307)



LUPES® LEAD

APPLICATIONS

Trawl/Bridle Line
 Gillnet & Cork Line
 Other Fishing Line

BENEFITS / FEATURES

Quick Sink Rate
 Durable



SPECIFICATIONS

Material	:	Cover : HT Polyester Fiber Core : Lead Chain
Specific Gravity	:	1,35-1,45 kg/dm ³
Construction	:	Cover : 16-24-32 Plaited Core : Parallel Lead Chain
UV Resistance	:	Excellent
Chemical Resistance	:	Good
Melting Point	:	256°C
Critical Temperature	:	170°C
Elongation At Break	:	Approx. %16
Fiber Water Absorption	:	Approx. %1-2
Wet Abrasion	:	Good
Dry Abrasion	:	Good
Standard	:	-
Length	:	Upon Request

Other Colours & Larger Diameters Upon Request

DIA (mm)	Weight (kg/100m)	B.Load (kgf)	DIA (inch)	Weight (lbs/100ft)	B.Load (lbs)
12	50,00	-	1/2"	33,60	-
16	100,00	-	5/8"	67,20	-
22	200,00	-	7/8"	134,40	-
30	300,00	-	1-1/4"	201,60	-

*Unspliced Break Load (All tests are in Accordance with ISO 2307)



LUPES® LEAD ▶ FISH FARMING ROPES



LUPES® PLAIN

APPLICATIONS

Other Fishing Line

BENEFITS / FEATURES

Outstanding Flexibility
 Easy to Splice
 Great Value for Money
 Durable
 Very Long Service Life



SPECIFICATIONS

Material	:	Cover: HT Polyester Fiber Core: HT Polyester Fiber
Specific Gravity	:	1,38 kg/dm ³
Construction	:	Cover: 16-24 Plaited, Core: 12 Plaited
UV Resistance	:	Excellent
Chemical Resistance	:	Good
Melting Point	:	256°C
Critical Temperature	:	170°C
Working Stretch	:	<6%
Fiber Water Absorption	:	Approx. %1-2
Wet Abrasion	:	Good
Length	:	100-200 m Plastic Spool

Other Colours & Larger Diameters Upon Request

DIA (mm)	Weight (kg/100m)	B.Load (kgf)	DIA (inch)	Weight (lbs/100ft)	B.Load (lbs)
6	3,15	1.080	1/4"	2,12	2.376
8	5,30	1.550	5/16"	3,56	3.410
10	8,20	2.330	3/8"	5,51	5.126
12	11,45	3.270	1/2"	7,69	7.194

*Unspliced Break Load (All Tests are in Accordance with ISO 2307)



LUPES® CORD

APPLICATIONS

Crab Rope
Gillnet & Cork Line
Longline
Other Fishing Line

BENEFITS / FEATURES

Outstanding Flexibility
Great Value for Money
Low Stretch

SPECIFICATIONS

Material : Cover: HT Polyester Fiber
Core: HT Polyester Fiber
Specific Gravity : 1,38 kg/dm³
Construction : Cover: 16-20 Plaited
Core: Parallel Braided
UV Resistance : Excellent
Chemical Resistance : Good
Melting Point : 256°C
Critical Temperature : 170°C
Working Stretch : <5%
Fiber Water Absorption : Approx. %1-2
Wet Abrasion : Good
Length : 100-200 m Plastic Spool

Other Colours & Larger Diameters Upon Request

DIA (mm)	Weight (kg/100m)	B.Load (kgf)	DIA (inch)	Weight (lbs/100ft)	B.Load (lbs)
3	0,85	180	1/8"	0,57	396
4	1,20	300	5/32"	0,81	660
5	1,95	460	3/16"	1,31	1.012
6	2,70	660	1/4"	1,81	1.452

*Unspliced Break Load (All Tests are in Accordance with ISO 2307)

LUPA® CORD

APPLICATIONS

Longline
Other Fishing Line

BENEFITS / FEATURES

Outstanding Flexibility
Great Value for Money
Excellent Shock Absorption

SPECIFICATIONS

Material : Cover: HT Polyamide Fiber
Core: HT Polyamide Fiber
Specific Gravity : 1,14 kg/dm³
Construction : Cover: 16-20 Plaited
Core: Parallel Braided
UV Resistance : Very Good
Chemical Resistance : Good
Melting Point : 218°C
Critical Temperature : 130°C
Working Stretch : <12%
Fiber Water Absorption : Approx. %3-4
Wet Abrasion : Sufficient
Length : 100-200 m Plastic Spool

Other Colours & Larger Diameters Upon Request

DIA (mm)	Weight (kg/100m)	B.Load (kgf)	DIA (inch)	Weight (lbs/100ft)	B.Load (lbs)
3	0,70	200	1/8"	0,47	440
4	1,00	330	5/32"	0,67	726
5	1,60	500	3/16"	1,08	1.100
6	2,25	720	1/4"	1,51	1.584

*Unspliced Break Load (All Tests are in Accordance with ISO 2307)

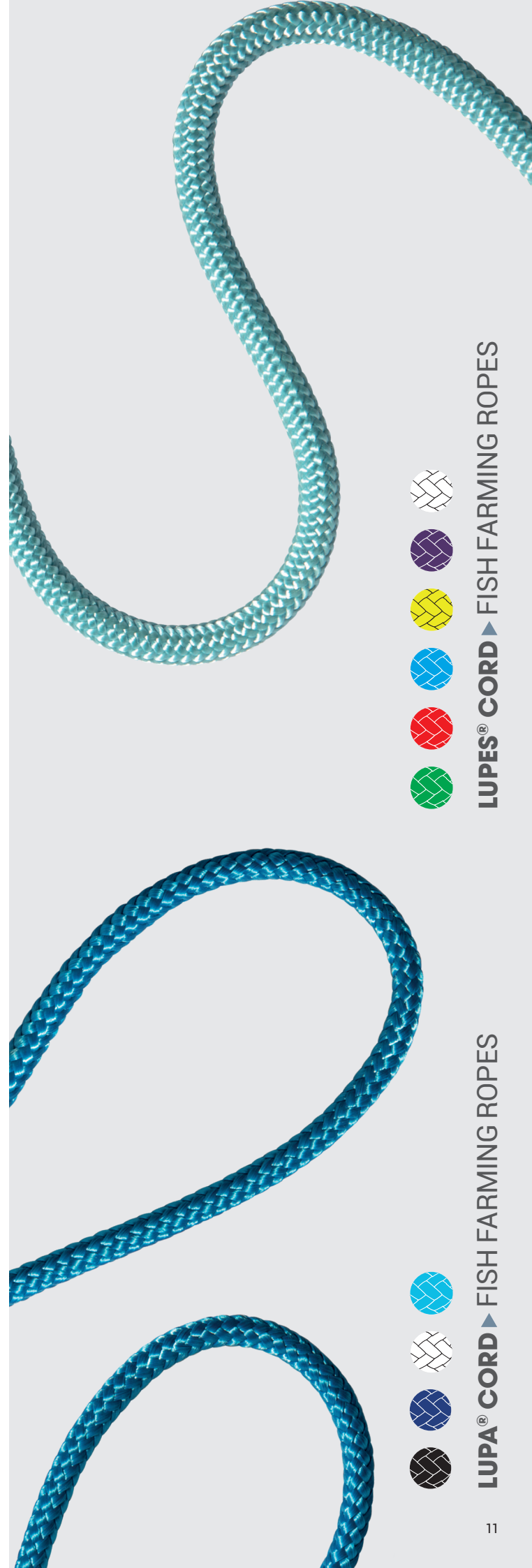

LUPES® CORD ▶ FISH FARMING ROPES



LUPA® CORD ▶ FISH FARMING ROPES



DYNE K® SBF SHACKLE

APPLICATIONS

Connection Line

BENEFITS / FEATURES

- Can be Opened and Closed Quickly
- Buoyant
- Very Low Stretch
- Self-Locking Under Load
- Easy to Use
- Extremely Durable

SPECIFICATIONS

Material	: Coated Dyneema® SK 78
Specific Gravity	: 0,97 kg/dm ³
Construction	: 12 Strand Plaited
UV Resistance	: Excellent
Chemical Resistance	: Excellent
Melting Point	: 147°C
Critical Temperature	: 65°C
Working Stretch	: <1,5%
Wet Abrasion	: Excellent
Dry Abrasion	: Excellent
Standard	: ISO 10325
Length	: -

Other Colours & Larger Diameters Upon Request

Shackle DIA (mm)	Rope DIA (mm)	Total Length in Closed Condition (cm)	Weight (kg)	Min. B.Load (kgf)	Shackle - 1		Shackle - 2		Shackle - 3	
					Weight (kg)	Min. B.Load (kgf)	Weight (kg)	Min. B.Load (kgf)	Weight (kg)	Min. B.Load (kgf)
12	7	12,5	0,03	4.670	0,05	10.508	0,07	15.785		
14	8	15,0	0,05	5.980	0,07	13.455	0,11	20.212		
18	10	17,5	0,09	9.380	0,13	21.105	0,20	31.704		
20	12	20,0	0,14	13.460	0,21	30.285	0,32	45.495		
24	14	35,0	0,33	18.360	0,49	41.310	0,75	62.057		
28	16	40,0	0,48	23.700	0,72	53.325	1,11	80.106		
32	18	45,0	0,68	28.500	1,03	64.125	1,57	96.330		
34	20	50,0	0,93	34.000	1,39	76.500	2,13	114.920		
36	22	55,0	1,24	40.800	1,85	91.800	2,84	137.904		
40	24	60,0	1,59	47.940	2,38	107.865	3,65	162.037		
44	26	65,0	2,00	55.080	3,00	123.930	4,59	186.170		
48	28	70,0	2,49	62.220	3,74	139.995	5,73	210.304		
50	30	75,0	3,04	70.380	4,55	158.355	6,98	237.884		
54	32	80,0	3,68	79.560	5,52	179.010	8,46	268.913		
58	34	85,0	4,41	87.720	6,61	197.370	10,13	296.494		
60	36	90,0	5,18	95.880	7,78	215.730	11,92	324.074		
64	38	95,0	6,06	106.080	9,10	238.680	13,95	358.550		
68	40	100,0	7,05	115.260	10,57	259.335	16,21	389.579		
72	42	110,0	8,54	124.440	12,80	279.990	19,63	420.607		

Spliced Break Load (All tests are in Accordance with ISO 2307)



Shackle - 1



Shackle - 2



Shackle - 3



ELASTIC CORD

APPLICATIONS

Other Fishing Line

BENEFITS / FEATURES

Premium Quality Rubber Core
Durable
High Elongation
Compact Construction

SPECIFICATIONS

Material	:	Cover: HT Polyester Fiber Core: Elastic Rubber
Specific Gravity	:	Approx. 1,38 kg/dm ³
Construction	:	Cover: 32 Plaited, Core: Parallel Braid
UV Resistance	:	Excellent
Chemical Resistance	:	Good
Melting Point	:	256°C
Critical Temperature	:	170°C
Fiber Water Absorption	:	Approx. %1-2
Wet Abrasion	:	Good
Dry Abrasion	:	Good
Length	:	100-200 m Plastic Spool

Other Colours & Larger Diameters Upon Request

DIA (mm)	Weight (kg/100m)	Min. B.Load (kgf)	DIA (inch)	Weight (lbs/100ft)	Min. B.Load (lbs)
3	0,75	-	1/8"	0,50	-
4	1,30	-	5/32"	0,87	-
5	2,10	-	3/16"	1,41	-
6	3,00	-	1/4"	2,02	-
8	4,30	-	5/16"	2,89	-
10	8,20	-	3/8"	5,51	-
12	12,00	-	1/2"	8,06	-

*Spliced Break Load (All tests are in Accordance with ISO 2307)

LUPP® CORD

APPLICATIONS

Longline
Other Fishing Line

BENEFITS / FEATURES

Outstanding Flexibility
Economically Priced
Low Stretch
Buoyant

SPECIFICATIONS

Material	:	Cover: HT Polypropylene Fiber Core: HT Polypropylene Fiber
Specific Gravity	:	0,91 kg/dm ³
Construction	:	Cover: 16 Plaited, Core: Parallel Braided
UV Resistance	:	Sufficient
Chemical Resistance	:	Very Good
Melting Point	:	165°C
Critical Temperature	:	80°C
Working Stretch	:	<6%
Fiber Water Absorption	:	None
Wet Abrasion	:	Sufficient
Length	:	100-200 m Plastic Spool

Other Colours & Larger Diameters Upon Request

DIA (mm)	Weight (kg/100m)	B.Load (kgf)	DIA (inch)	Weight (lbs/100ft)	B.Load (lbs)
4	0,70	250	5/32"	0,47	550
5	1,20	400	3/16"	0,81	880
6	1,60	550	1/4"	1,08	1.210

*Unspliced Break Load (All Tests are in Accordance with ISO 2307)

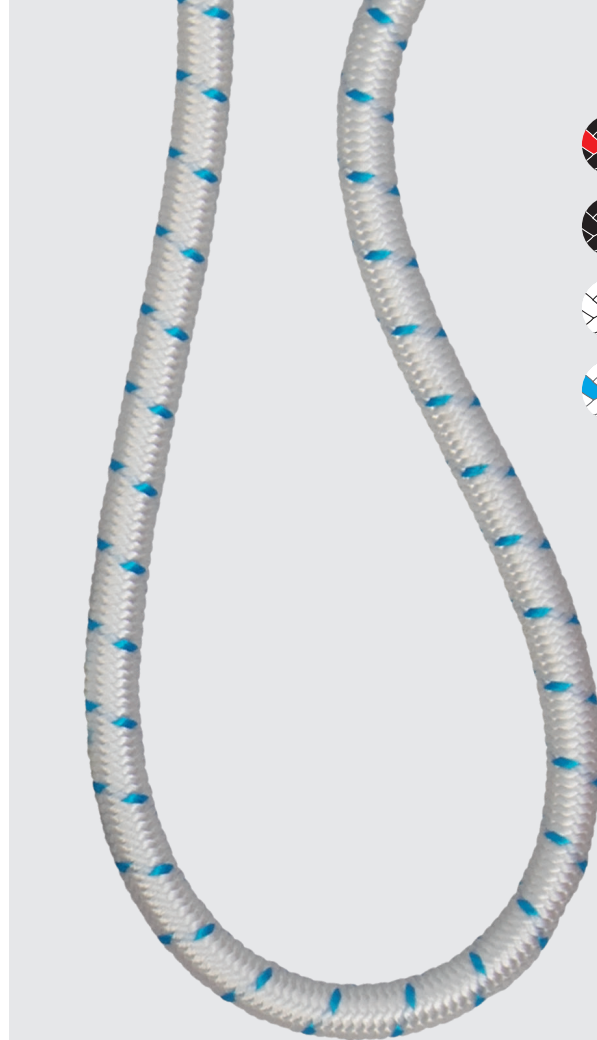

ELASTIC CORD ▲ FISH FARMING ROPES

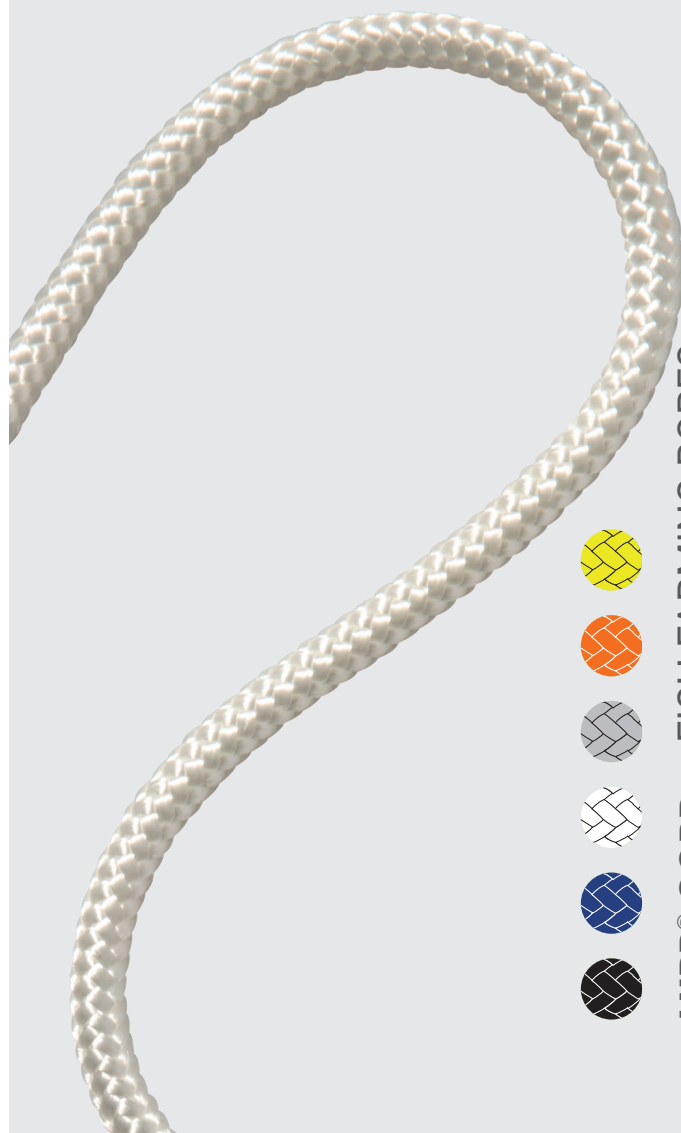

LUPP® CORD ▲ FISH FARMING ROPES

LE-1 BAND WEBBING SLING

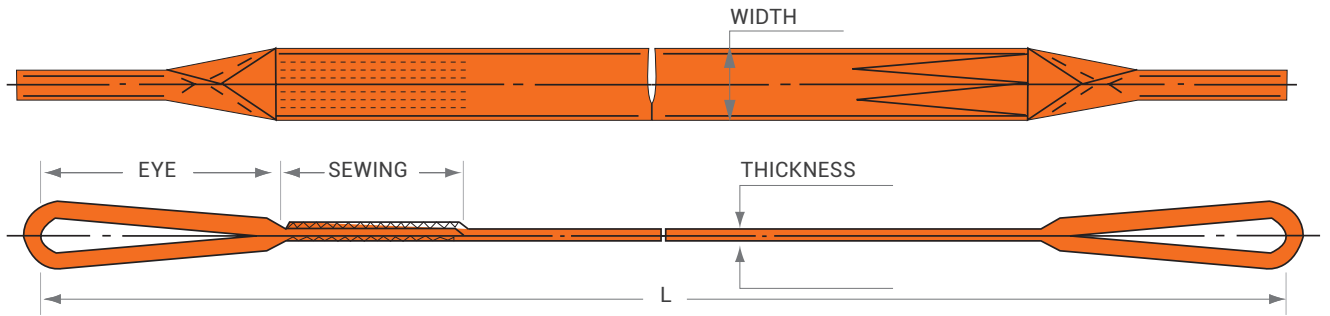

SPECIFICATIONS





Material : 100% HT Polyester Webbing
 Standard : EN 1492-1+A1
 Safety Factor : 7:1







BENEFITS / FEATURES

High quality product with the 7:1 safety factor
 Produced from the high strength polyester webbing
 Various sizes available for every application
 Not slippery
 High resistance to chemical and oil contamination
 Custom made slings for specific applications may be made to customer specifications
 Various colour are available



	Width (mm)	Working Load (kgf 100%)	Working Load (kgf 80%)	Working Load (kgf 200%)	Angle (0-45°) Working Load (kgf)	Angle (45-60°) Working Load (kgf)	Breaking Load (kgf)	Working Load (kgf)	Length (m)
VIOLET	30-50	1000	800	2000	1400	1000	7000	1000	1-10
GREEN	70	2000	1600	4000	2800	2000	14000	2000	2-10
YELLOW	90	3000	2400	6000	4200	3000	21000	3000	2-10
GRAY	120	4000	3200	8000	5600	4000	28000	4000	4-10
RED	150	5000	4000	10000	7000	5000	35000	5000	4-10
BROWN	180	6000	4800	12000	8400	6000	42000	6000	4-10
BLUE	250	8000	6400	16000	11200	8000	56000	8000	5-10
ORANGE	300	10000	8000	20000	14000	10000	70000	10000	5-10

-  1. Flat eye
-  2. Reversed eye
-  3. Folded eye 1/2 width from 1 side
-  4. Folded eye 1/2 width from 2 sides
-  5. Folded eye 1/3 width

	0° 100%		60° 85%
	30° 95%		90° 75%
	45° 90%		120° 50%

LE-2 ROUND WEBBING SLING

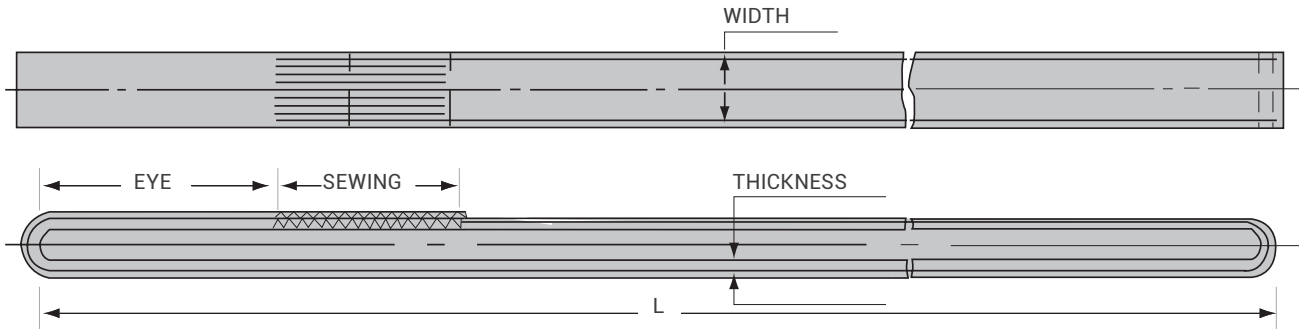

SPECIFICATIONS

Material : 100% HT Polyester Webbing
 Standard : EN 1492-2+A1
 Safety Factor : 7:1

BENEFITS / FEATURES

- High quality product with the 7:1 safety factor
- Produced from the high strength polyester webbing
- Various sizes available for every application
- Not slippery
- High resistance to chemical and oil contamination
- Custom made slings for specific applications may be made to customer specifications
- Various colour are available

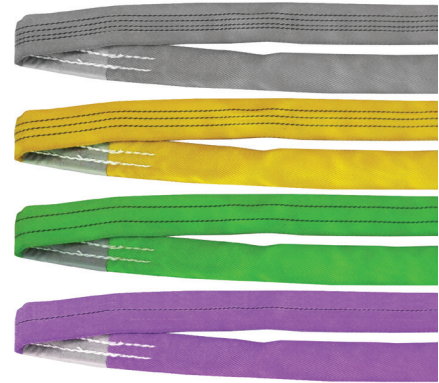

	Width (mm)	Working Load (kgf 100%)	Working Load (kgf 80%)	Working Load (kgf 200%)	Angle (0-45°) Working Load (kgf)	Angle (45-60°) Working Load (kgf)	Breaking Load (kgf)	Working Load (kgf)	Length (m)
VIOLET	25	1000	800	2000	1400	1000	7000	1000	1-10
GREEN	50	2000	1600	4000	2800	2000	14000	2000	2-10
YELLOW	75	3000	2400	6000	4200	3000	21000	3000	2-10
GRAY	100	4000	3200	8000	5600	4000	28000	4000	4-10
RED	125	5000	4000	10000	7000	5000	35000	5000	4-10
BROWN	150	6000	4800	12000	8400	6000	42000	6000	4-10
BLUE	200	8000	6400	16000	11200	8000	56000	8000	5-10
ORANGE	250	10000	8000	20000	14000	10000	70000	10000	5-10

	0° 100%		60° 85%
	30° 95%		90° 70%
	45° 90%		120° 50%

SUGGESTED MOORING ROPES FOR VARIOUS CLASSES OF VESSELS

PASSANGER VESSELS , RO-RO, CAR-CONTANIER CARRIERS		DYNE® K / FORCE K®	LUPA® ROUND	LUPP® SQUARE FILM	PP NORMAL	LUPA® SQUARE
∅						
DWT	3.-5.000 DWT	22	44	48	56	44
	5.-12.000 DWT	24	48	52	60	48
	12.-25.000 DWT	26	52	56	64	52
	25.-40.000 DWT	28	56	60	72	56
	40.-80.000 DWT	32	60	64	76	60
	ABOVE 80.000 DWT	36	64	68	80	64
BULKCARRIERS, TANKERS		DYNE® K / FORCE K®	LUPA® ROUND	LUPP® SQUARE FILM	PP NORMAL	LUPA® SQUARE
∅						
DWT	5.-10.000 DWT	24	44	48	56	44
	10.-20.000 DWT	26	48	52	60	48
	20.-40.000 DWT	32	52	56	64	52
	40.-80.000 DWT	36	56	60	72	56
	80.-150.000 DWT	38	60	64	76	60
	150.-250.000 DWT	40	64	68	80	64
	ABOVE 250.000 DWT	44	68	72	88	68

SUGGESTED MOORING & ANCHOR LINE FISH FARMING

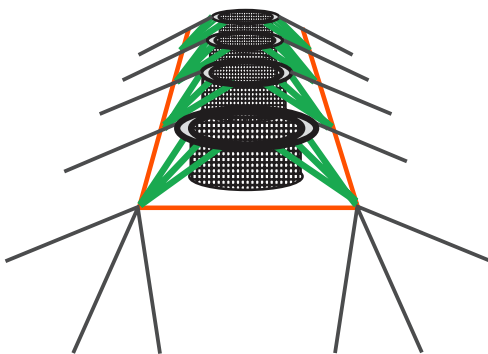

- Ø20 MM – Ø36 MM
LUPA® ROUND / SQUARE / TWIST
(SINKING) POLYAMIDE FIBER
- Ø36 MM – Ø40 MM
LUPA® ROUND / SQUARE / TWIST
(SINKING) POLYAMIDE FIBER
- Ø40 MM – Ø56 MM
LUPP® SQUARE FILM
(FLOATING) POLYOLEFIN FIBER

NOTE: ROPE DIAMETERS MENTIONED ABOVE CHANGE ACCORDING TO SIZE OF FISHFARMS.
THEREFORE, MINIMUM AND MAXIMUM VALUES ARE USED.

ROPE LENGTH ACCORDING TO DIAMETER & REEL SIZE

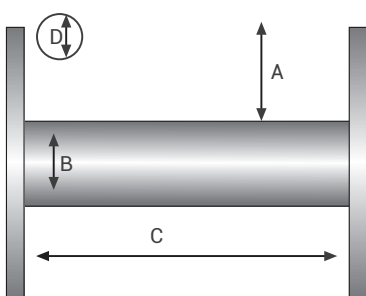

ROPES LENGTH (METER) :
$$\frac{(A+B) \cdot A^2 \cdot C \cdot \pi^2 \cdot 10^6}{D^2}$$

A,B,C: (METER) : D: (MM)

CONVERSION TABLE

	TO CONVERT	MULTIPLY BY	TO CONVERT	MULTIPLY BY
WEIGHT	POUNDS TO GRAMS	453592	GRAMS TO POUNDS	0,002205
	POUNDS TO KILOGRAMS	0,4536	KILOGRAMS TO POUNDS	2,20462
	TONS TO KILOGRAMS	1016,05	KILOGRAMS TO TONS	0,0009842
	POUNDS TO OUNCES	16	OUNCES TO POUNDS	0,0625
	POUNDS/100 FEET TO GRAMS/METERS	14,8816394	GRAMS/METERS TO POUNDS / 100 FEET	67,0969
STRENGTH	KILOGRAMS TO KILONEWTONS	0,0098	KILONEWTONS TO KILOGRAMS	101,972
	TONS TO NEWTONS	9810	NEWTONS TO TONS	0,000102
LENGTH	INCHES TO MILIMETERS	25,40	MILIMETERS TO INCHES	0,03937
	FEET TO METERS	0,3048	METERS TO FEET	3,208
	FEET TO INCHES	12	INCHES TO FEET	0,833
	YARDS TO METERS	0,9144	METERS TO YARDS	1,0936
	YARDS TO FEET	3	FEET TO YARDS	0,333
	MILES TO KILOMETERS	1,6093	KILOMETERS TO MILES	0,6214
	CIRC. INCHES TO DIAMETER MILIMETERS	8	DIAMETERS MILIMETERS TO CIRC. INCHES	0,125
AREA	SQUARE FEET TO SQUARE METERS	0,0929	SQUARE METERS TO SQUARE FEET	10,7639
	SQUARE YARDS TO SQUARE METERS	0,8361	SQUARE METERS TO SQUARE YARDS	1,1960
TEX-SYSTEM	DENIER	WT. ING/9000M	TEX TO DTEX	10
	TEX	WT. ING/1000M	DEN TO TEX	0,111
	DTEX	WT. ING/10.000M	CN/DTEX	GR/DEN



STANDARDS OF ROPES

EN ISO 9554	Fibre Ropes - General Specifications
EN ISO 1968	Fibre Ropes and Cordage - Vocabulary
EN ISO 2307	Fibre Ropes - Determination of Certain Physical and Mechanical Properties
EN ISO 1140	Fibre Ropes - Polyamide - 3, - 4 and - 8 Strand Ropes
EN ISO 1141	Fibre Ropes - Polyester - 3, - 4 and - 8 Strand Ropes
EN ISO 1346	Fiber Ropes - Polypropylene - 3, - 4 and - 8 Strand Ropes
EN ISO 1181	Fibre Ropes - Manila and Sisal - 3,- 4 and - 8 Strand Ropes
ISO 10547	Polyester Fibre Ropes - Double Braid Construction
ISO 10554	Polyamide Fibre Ropes - Double Braid Construction
ISO 10572	Mixed Polyolef in Fibre Ropes
ISO 10325	Fibres Ropes - High Modulus Polyethylene - 8 Strand Braided Ropes, 12 Strand Braided Ropes and Covered Ropes
ISO 10556	Fibres Ropes of Polyester/Polyolef in Dual Fibres
EN 1891	Personel Protective Equipment for The Prevention of Falls From A Height - Low Stretch Kernmantel Ropes
EN 892	Mountaineering Equipment - Dynamic Mountaineering Ropes - Safety Requirements and Test Methods
EN 564	Mountaineering Equipment - Accessory Cord - Safety Requirements and Test Methods

STANDARDS OF ROPES

MIL-DTL 24050E	Polyamide Fibre Ropes - Double Braid Construction
----------------	---

STANDARDS OF SLINGS

EN 1492-1+A1	Textile Slings - Safety - Part 1: Flat Woven Webbing Slings, Made of Man - Made Fibers for General Purpose Use
EN 1492-2+A1	Textile Slings - Safety - Part 2: Roundslings, Made of Man - Made Fibers for General Purpose Use

QUALITY - TEST

Kaya Ropes manufactures all kinds of ropes with technical specifications that are suitable for all kind of conditions & ropes made for a specific field with international quality certifications also offering a wide range of construction type and raw materials for every field where the safety of human life and property is of prime concern.

For certain type of products, Kaya Ropes has the type approval and inspection certificates from Turk Loydu. Additionally, Kaya Ropes offers inspection certificates from DNV-GL and Bureau Veritas upon special request from their clients.







AUGUST HERZOG
Maschinenfabrik Gmbh & Co.Kg
AM Alexanderhaus 160 26127
Oldenburg Germany
Phone: +49 (0)441 3008 0
Fax: +49 (0)441 3008 100
E-mail: info@herzog-online.com
www.herzog-online.com



GALAN TEXTILE MACHINERY S.L.
Francesc Oller, 91 E-08225
Terrassa (Barcelona) Spain
Phone: +34 93 733 65 50
Fax: +34 93 788 40 40
E-mail: galan@galan.es
www.galan.es



TWISTECHNOLOGY
Ctra. de Rubi, km 22. E-08228
Terrassa (Barcelona) Spain
Phone: +34 937 894 100
Fax: +34 937 894 355
E-mail: info@twistechology.com
www.twistechology.com



ROBCO ENGINEERING A/S
Kjeldgaardsvej 6
9300 Saeby Denmark
Phone: +45 98 46 40 00
Fax: +45 98 46 18 00
E-mail: info@robco-eng.com
www.robco-eng.com



SIMA GROUP
Via Chiesaccia, 2 40056
Crespellano (BO) Italy
Phone: +39 0516505511
Fax: +39 051739588
E-mail: simagroup@simagroup.it
www.simagroup.it



ZWICK GMBH & CO. KG
August-Nagel-Str. 11 D-89079
Ulm Germany
Phone: +49 (0)7305 10 0
Fax: +49 (0)7305 10 200
E-mail: info@zwick.de
www.zwick.de



DSM DYNEEMA B.V.
6129 El Urmond The Netherlands
Phone: +31 (0)46 4767989
Fax: +31 (0)46 4767915
E-mail: info.dyneema@dsm.com
www.dyneema.com



TEIJIN ARAMID B.V.
Velperweg 76 P.O. Box 5153
6802 ED Arnhem The Netherlands
Phone: +31 0 88 26 89 159
Fax: +31 0 88 26 89 179
E-mail: ropes_cables@teijinaramid.com
www.teijinaramid.com



NEXIS FIBERS AG
Gerliswilstrasse 17 6021
Emmenbrücke Switzerland
Phone: +41 (0)41 267 80 53
Fax: +41 (0)41 267 92 16
www.nexisfibers.com



I-COATS N.V.
I-Coats N.V. K. Mercierlei 29
2600 Berchem Belgium
Phone: +32 3 281 73 03
Fax: +32 3 281 73 04
E-mail: kvg@i-coats.be
www.i-coats.be

KAYA HALAT AŞ

Yönetim ve Üretim Merkezi
Management & Production Center

Gebze Organize Sanayi Bölgesi,
1000. Sokak No: 1015
Çayırova, Kocaeli, Turkey
kayagrubu.com.tr

Santral/Central

T: +90 262 677 19 19 pbx
F: +90 262 677 19 10







KAYA ROPES

Gebze Organize Sanayi Bölgesi,
1000. Sokak No: 1015
Çayırova, Kocaeli, Turkey
T: +90 262 677 19 03 pbx
F: +90 262 677 19 01
info@kayaropes.com
kayaropes.com

KAYA ROPES USA

KAYA USA LLC
2701 NW 2nd Ave. #205
Boca Raton Florida, 33431
United States Of America
T: +1 561 303 57 63
info@kayausa.us
kayaropes.com/en-US/

 /KayaRopes
 /in/kayaropes
 /KayaRopes
 /KayaRopes